

C 1974

A SCIENTIFIC SEARCH FOR NEW IMAGES ON THE HOLY
SHROUD OF TURIN BY COMPUTER ENHANCEMENT

Donald Devan**

Eric Jumper, Ph.D.*

John Jackson, Ph.D.

INTRODUCTION

The Shroud has held a special interest in our minds for many years as it has for so many others. Because of our fields of expertise in science, it was natural for us to examine ways in which knowledge of the Shroud might be increased using the tools of our trade. One of the thoughts that came to mind was to attempt to increase this knowledge through the use of computer techniques developed in recent years for the purpose of enhancing or improving photographic images for subsequent scientific re-evaluation. This paper describes our assessment of the results of our experiment in the application of a specific image enhancement technique to a group of photographic images of the Shroud.

There are two natural questions which may be asked with regards to computer enhancement of the Shroud pictures: 1. Can the Shroud images be enhanced "aesthetically", that is, can their spiritual and meditative effects, their "presence", be heightened for the human viewer and 2. can the enhanced imagery reveal or suggest improved "scientific" (detailed) information about specific features on the Shroud? To us, the first question is about the overall effect, the totality of our human response to the images, while the second question concerns the analysis of the Shroud images, the separation of the totality of the images into distinct components. So, in a sense, the two questions are of opposing nature and therefore should properly be treated by separate

*Ph.D. to be awarded October 1975

**Image Enhancement Specialist

investigations. Being scientists, we were interested primarily in possible scientific information which might be gained through computer enhancement and so we have directed our efforts in response to the second question, the results of which are reported herein. However, we believe the first question is also important and should rightfully be the object of an additional study.

DESCRIPTION

To conduct our investigation, a commercially available filmstrip of the 1931 photographs of Enrie⁺ was used which consisted of source transparencies for a computer process which involved the transformation of visual information contained in the gray shades (of photographic density or opacity) of the image on each photograph into a set of numerical values. These values were stored in the memory of a computer system in such a way that this numerical representation of the image could be manipulated by the computer and then recreated on a viewing screen as the computer enhanced version of the original image. This numerical transformation-recreation process involved several types of computer and image processing devices: an image scanning system developed by Information Science, Inc., Control Data Corporation 3600 and 160 A Computer Systems, and a DICOMED Corporation Image Display System. The functions of these devices are described in detail in Appendix A; they are also summarized below to give the less-technical reader some concept of the process of converting a viewable photographic image into its numerical counterpart.

+Produced by Don Bosco Filmstrips - F 13 La Santa Sindone

The film "scanning" process, depicted in Figure 1, involves a small but finite spot of light which is moved across the film from one side to the other in a series of horizontal "stripes" or scan lines, one under the other (The effect of a finite sized spot in reducing the sharpness of a given image and how it can be overcome is discussed at the end of Appendix A). At each point in the spot's path, the amount of light passing through the photograph is attenuated from the intensity of light incident on the film to the degree that the image is opaque (dense). The intensity of emerging light is then measured and assigned a numerical value, point-by-point across and along the film, then stored on a magnetic computer tape. In essence, when the scan is complete, the numerical image is stored by the computer as though it were a mosaic of small, adjacent tiles of varying opacities. In its numerical form, the image is said to be digitized.

The image of the Shroud was digitized in this manner and the resulting numerical representation was processed by the computer so as to yield a second numerical representation called a computer enhanced image. The mathematical details of the technique used to perform this enhancement process are given in Appendix B. The concept behind the particular technique used for most of the Shroud images is based on a theorem in the science of "Information Theory" which says that the discernable information content of an image is at its maximum when every possible numerical value of opacity appears the same number of times in the image's numerical representation. In other words, imagine that

the original, digitized image had so many points of density value "1", so many of value "2", so many of value "10", etc., depending on the pattern of dark and light areas in the Shroud photograph itself. Then, the enhanced image might have each point of initial value "2" changed to value "6" (for example), each point of value "10" changed to value "12", etc. in such a way that the resultant enhanced image had about the same number of points with value "1", as those with value "2", as those with value "10", etc. as required by the above-mentioned theorem.

Additionally, for one image (Figure 12), a second computer process called "Gamma-Enhancement" was applied to the numerical array. This process was used to expand the contrast of light areas of the image at the expense of the darker so as to exaggerate the contrast between the light and dark regions.

The transformed images appearing with this paper were recreated in visual form on the Image-Display System and were then rephotographed from its viewing screen.

RESULTS

Based upon the process just described, let us now turn to the pictures resulting from that process shown in Figures 2 through 12. The even figure numbers are the originals scanned and the odd are those of the enhanced image of the previous figure (with the exception of Figure 12 which was mentioned in the above section).

At first glance, some of the enhanced images might seem poorer in quality than the originals, but let us examine them more closely in light of the scientific question posed earlier.

Let us begin by turning to Figure 3. Here, we see that the fainter portions of the image have been exaggerated so that the outline of the hair and shoulders are more noticeable. These edges of the image are not distinct but are somewhat hazy. Thus, this important characteristic of the Shroud image, noted for example by Vignon (Reference 1), is preserved by computer enhancing. By way of contrast, let us go to Figure 5. A noticeable departure from this rule is found around the edges of the face. Though not a new observation (References 1 and 2), it is significant that in the computer enhanced picture where levels of contrast are inserted between otherwise neighboring densities (See Appendix B for details), the edge of the face is still sharp and distinct. It is our opinion that this reinforces the theory noted by Barbet (Reference 2) that a bandage was wrapped under the chin and around the face to keep the mouth from falling open.

Figure 7 is extremely interesting for it reveals some features on the Shroud we had not otherwise noticed: the outline of the hips, the filling in of the stomach area, and most interestingly, the existence of a thumb not previously identified by investigators of the Shroud (References 2 and 3). This observation, if correct, would tend to discount Barbet's speculation that the thumb remained drawn into the palm of the hand at the time of burial. Indeed, our findings suggest that the thumb was in the more natural position along the lower (right) arm as shown in Figure 7a.

In as much as the absence of the thumbs on the Shroud has generated significant medical discussion in the past, we thought that an independent

experiment ought to be performed to see if the thumblike feature appearing in the computer picture could properly be identified as a thumb. To do this, we constructed a full-sized cloth model (of new, unbleached muslin) of the Shroud with the actual image of the body accurately drawn on it. We carefully placed this model over volunteer subjects so that appropriate features on their bodies coincided with those indicated on the cloth. We then asked them to place their thumb under the palms and to the side as in Figure 7a. The net effect of this was to raise and lower the knuckles of the top (left) hand a distance of about two centimeters, the thickness of their thumb. This shifted the contact point of the cloth with the right forearm by about 6 centimeters. Since the actual contact point on the Shroud is well determined as the point where the blood flow on the right forearm begins, comparison with the reconstructed contact point, we reasoned, ought to be a reliable way of determining the true position of the thumb. We performed this experiment with four individuals (same cloth) and consistently found that the onset of the blood flow is best explained by the thumb in the position indicated in the diagram, not in the position suggested by Barbet.

We do not wish to venture outside our realm of expertise by claiming that Barbet's opinion that the thumbs were drawn into the palms during the nailing is inconsistent with the Shroud image, but that at the time of burial, the thumbs appear not to be in the palms (at least for the top hand).

Additionally, we performed a second measurement, discussed in

Reference 4, which indicates that the thumb image has the intensity of a body feature about 2.7 centimeters below the cloth which is what would be expected for a thumb in the position of Figure 7a. This measurement further corroborates, we believe, our hypothesis that an image of the thumb is in fact present on the Shroud.

Returning to the set of computer pictures, let us examine Figure 9. Here, we see how the computer was able to fill in, so to say, the calf and ankle areas of the leg.

Figure 11 is probably the most interesting of all the computer enhanced pictures. Once again, the distinct images of the original are not made sharper, but some extremely faint images from the original are brought to light in the enhancement. These new images, which we had not noticed in the original prior to computer processing (Bulst, Reference 3 - page 134, comments on the absence of any side image), are found near the lower side of both legs just beneath the knees. Because of their appearance of seemingly "fanning out", as it were, from the body image, we believe them to be associated with the body image. But to be certain about this, we had to convince ourselves that they could not be arbitrary marks of some kind since the Shroud has a wealth of extraneous markings other than those directly related to the body. First of all, it is clear that these side images were not caused by the fire since the strength of these images does not increase in the direction of the source of the nearby fire damage (as do other marks associated with fire damage). Nor can they be attributed to water damage since in every case such marks appear as discrete rings.

One possibility, however, might be that they are shadows or some other anomalous feature associated only with the 1931 Enrie photographs which we scanned. If this is the case, then we would expect them not to appear on more recent photographs of the Shroud produced under different conditions of illumination. To test this possibility, we obtained a 1973 photographic 35mm Bob Wilcox slide (Reference 5) and scanned it with a microdensitometer, a device which accurately plots image intensity along the scan path over the image. Though the contrast of the 1973 picture was not high enough (as in the Enrie photos) to visually indentify the faint side image, this image, nevertheless, was detected by the scanning device. Thus, we were led to conclude that these side images are real and do, in fact, appear on the Shroud.

These considerations, then, led us to ask the following question. Can they be identified as part of the body image when the computer enhancement photograph of Figure 11 does not show side images anywhere else along the body? It is our opinion that they can because there is no other place where a side image can logically be expected to occur other than along the side of the knees. For instance, the absence of one at the side of the head (or at the top) might be explained by the chin bandage (as mentioned previously above) and any side image along the arms would have been destroyed by the fire. Finally, the absence of a side image along the hips could be explained by the cloth being held away from that area by the extended elbows and raised knee.

(In Reference 4 we show that body images were not formed at distances greater than about 5 centimeters and the body-cloth separation at the

hip is greater than that). Thus, the only place where a side image could be expected to be found owing to either its survivability or proximity to the cloth is where, indeed, one appears on the computer enhanced picture; hence, we believe, there is no inconsistency in identifying these new images as part of the body image.

We think the existence of such a side image is significant because this suggests that it was formed by the same process which formed the body image. Clearly, this would imply that whatever process caused the body image on the Shroud had to have been one which was not only a vertical phenomenon but also a horizontal one.

Also visible on the computer enhanced photo of Figure 11 are still other images along the outside edges of the cloth. These can also be seen on the originals but not to the extent as on the computer pictures. We will attempt no identification of these images in the present paper but we believe they may be worth further investigation, perhaps with better source photographs.

Finally, Figure 12 shows the result of the Gamma Enhancement process mentioned earlier. We feel that this kind of enhancing may be helpful in better understanding how the cloth lay on Christ's body as well as the exact areas of cloth-body contact (since the resulting image seems to be essentially a map showing where the Shroud touched the body. Only the lightest parts of the image-presumably those closest to the cloth - were preserved in this special enhancement technique.)

APPENDIX A

FILM SCANNING PROCESS

The scanning of the Shroud transparencies is accomplished by a synchronous flying spot scanning system schematically illustrated in Figure 1. The probe beam of intensity I_0 intersects the film at point C corresponding to some x,y location on the film and attenuated according to

$$I(x,y) = I_0 T(x,y)$$

where $T(x,y)$ is the transmittance of the area of interest. The transmitted intensity, $I(x,y)$, is measured by a photomultiplier tube at D and expressed in logarithmic units (at E) of optical density $D = K \log_{10} T^{-1}$ prior to digitization (at point G) and storage on magnetic tape J. Figure 13 illustrates that the square (for the work reported in this paper, $1/1000 \times 1/1000$ of an inch - $6.452 \times 10^{-6} \text{ cm}^2$) scanning aperture moves across the film in the x -direction; through electronic and computer logic, digital numerical values d are assigned between 1 and 64 to each measured optical density. The film is likewise in synchronous continuous motion in the y -direction such that it has moved one-half of the aperture when one scan across the film has been made. Thus, by using three (of six) mirror faces of the rotating prism at B, the next data collection scan is accomplished when the film has moved a length of one aperture. In this fashion, it is possible to transform the analog film-recorded image, through digital means, into a matrix whose elements define a numerical density d for every spatial film (x,y) location.

Not shown in Figure 1 is the video display unit with the capability of recreating a photographic image from digital information available on magnetic tape. This allows the reconstruction of the scanned images or ones which have been processed by special contrast enhancement algorithms.

One aspect of this scanning process worth noting is that all features on the film of size less than 1/1000 of an inch are "averaged out" owing to the finite size of the scanning aperture. This implies, therefore, that a fundamental resolution exists with this system which may or may not be a problem depending on the size of the recorded features on the film being investigated. For the case of the Shroud transparencies which we scanned, this limitation never posed a major problem though some "bluriness" in the picture of the frontal image did noticeably occur. In the cases of the closeup pictures, however, the resolution achieved is better though not great enough to pick up image features smaller than about three thread widths of the Shroud ($\approx 1/100$ of an inch in actual size) and therefore details of the Shroud image of this size are absent in these computer pictures.

APPENDIX B

COMPUTER ENHANCEMENT ALGORITHM

After the image is encoded in digital form, it is ready for numerical processing. The algorithm chosen for this study is a histogram normalization method similar to one used in enhancing radiological images. It was selected because of its ability to bring photographic digital data into a form that best displays the total information content. This is accomplished by effectively placing intervals of contrast between otherwise neighboring densities for which visual distinction is very difficult if not impossible. Such contrast enhancement also makes extremely faint structures stand out against a background, a feature highly desirable in the case of the Shroud photos where weaker parts of the image tend to blend with the cloth.

The first step in the process is to construct a histogram giving the number of digital cells f at each numerical density d (See Figure 14). If it is assumed that each digital element contributes equally one unit of information, then $f(d)$ can be considered a plot showing how information is distributed over the available, numerical density spectrum. The problem, as mentioned above, is to spread this information evenly over all densities thereby maximizing the display of the information. After constructing the histogram, a summation function $F(D)$ given by

$$F(D) = \sum_{d=1}^D f(d) \quad (1)$$

is found for all D . Then, $F(D)$ is normalized over the range 1-64 to yield

another function $A(D)$ given by

$$A(D) = S \cdot [F(D) - F(1)] \quad (2)$$

where

$$S = 64/[F(64) - F(1)].$$

Then, if M is an operator which when applied to any number produces the greatest integer contained in it, as for example in $M(43.78) = 43$, then a third function $X(D)$ can be defined by

$$X(D) = M[A(D)]. \quad (3)$$

The monotonically increasing function $X(D)$ shown in Figure 15, then, defines a transformation which converts the numerical density D of each point x, y on the film to a new density X . In effect, this process rearranges the initial distribution $f(d)$ of measured densities to one called $g(d)$ shown in Figure 16, which tends towards a constant value independent of d . That this happens can be seen most easily by imagining the interval (1-64) contains an arbitrarily large number of densities, d , i.e., a continuous spectrum of densities. In this limit, Equations (1) and (3) would become

$$F(D) = \int_1^D f(x) dx; 1 \leq D \leq 64 \quad (4)$$

and

$$X(D) = S \cdot [F(D) - F(1)] \quad (5)$$

where

$$S = 64/[F(64) - F(1)].$$

For the discrete case,

$$g(d) = \sum_{X(D) = d} f(D) \quad (6)$$

where the summation is over all D such that $X(D) = d$, but in the limit of arbitrarily fine density intervals, Equation (6) becomes

$$g(d) = f(d) \left[1 / \frac{dX}{dD} \right]_{D=d} \quad (7)$$

and from Equations (4) and (5), equation 7 becomes

$$g(d) = \frac{F(64) - F(1)}{64}, \quad (8)$$

a function independent of d .

If, as mentioned above, f is taken to be the information density of the original photograph and g of the enhanced, then according to Equation (7),

$$\int_1^{64} g(X) dX = \int_1^{64} f(D) dD \quad (9)$$

indicating that this process conserves the total information content of the original image owing to the normalization of $X(D)$ in Equation (5). This also implies that no extraneous information is added or subtracted to the image.

Sometimes it is advantageous to construct $X(D)$ using $f(d)$ over a restricted interval $(n, 64)$ if very few digital points have densities between 1 and n . This allows free expansion of $f(d)$ over the entire

interval (1,64) without being hindered by the points lying in (1,n) and a fuller use of the available range of densities is achieved. In the enhancement photographs appearing in this paper, n is chosen to be 5 for the closeups and 12 for the frontal image.

One further point needs to be mentioned. It is not necessary in general to apply the algorithm to the entire image. Sometimes certain undesirable features can bias the construction of $X(D)$ resulting in a reduction of contrast enhancement on that part of the image under investigation. In such cases, the algorithm may be applied to selected areas of the image being careful to exclude the unnecessary parts. This was done in the enhancement of the frontal image over five separate regions since the very pronounced and large burn marks could significantly bias the enhancement of the fainter body image. Lines separating these regions can be seen in Figure 11.

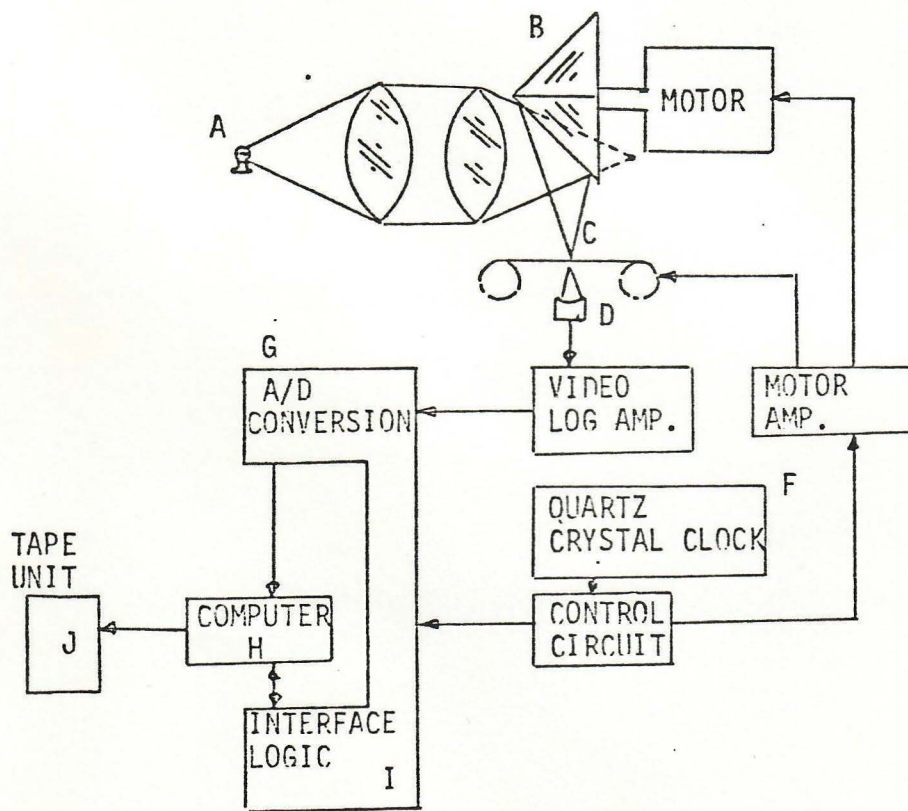

Figure 1.

Schematic of optical scanning device. Light originates at point A, reflects off rotating prism B, intersects film at C, and the amount of light unattenuated by the film is detected by photomultiplier at D. System components E through H convert the photomultiplier signal to a numerical value which is recorded on magnetic tape at J.

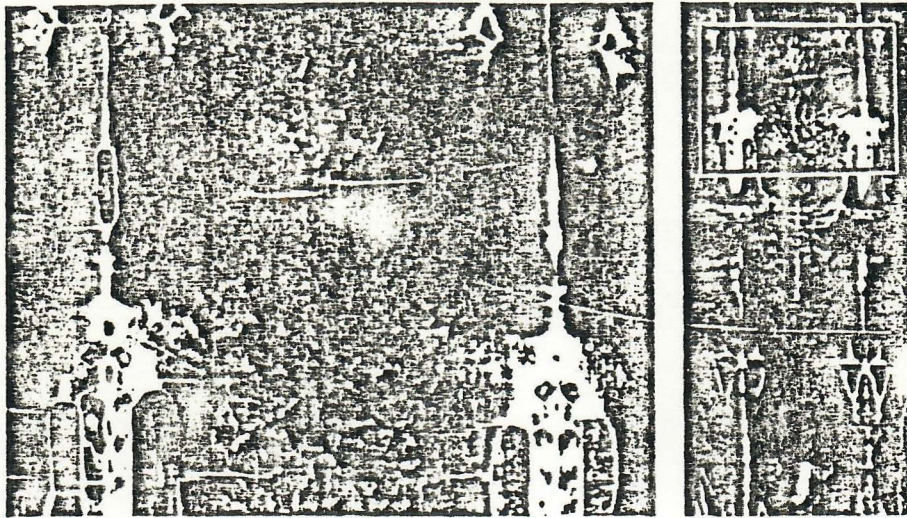

Figure 2. Normal picture of back of head.

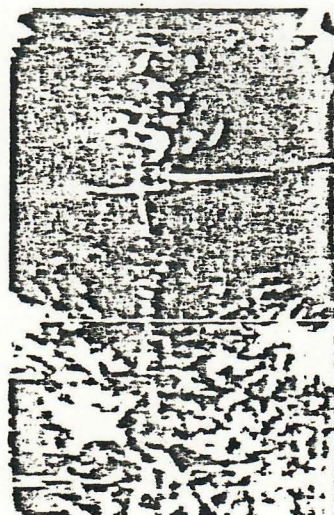

Figure 3. Computer enhanced version of back of head.

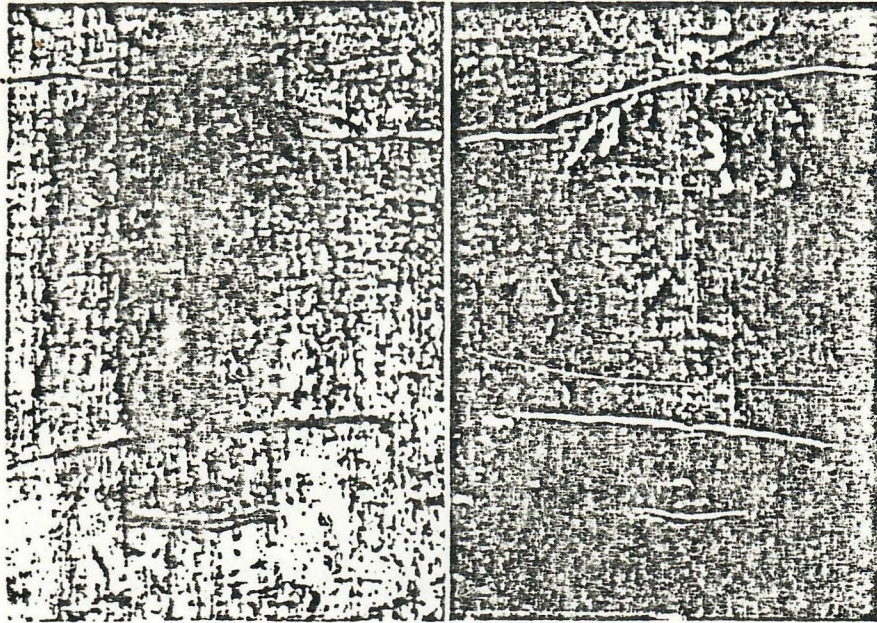

Figure 4. Normal picture of face.

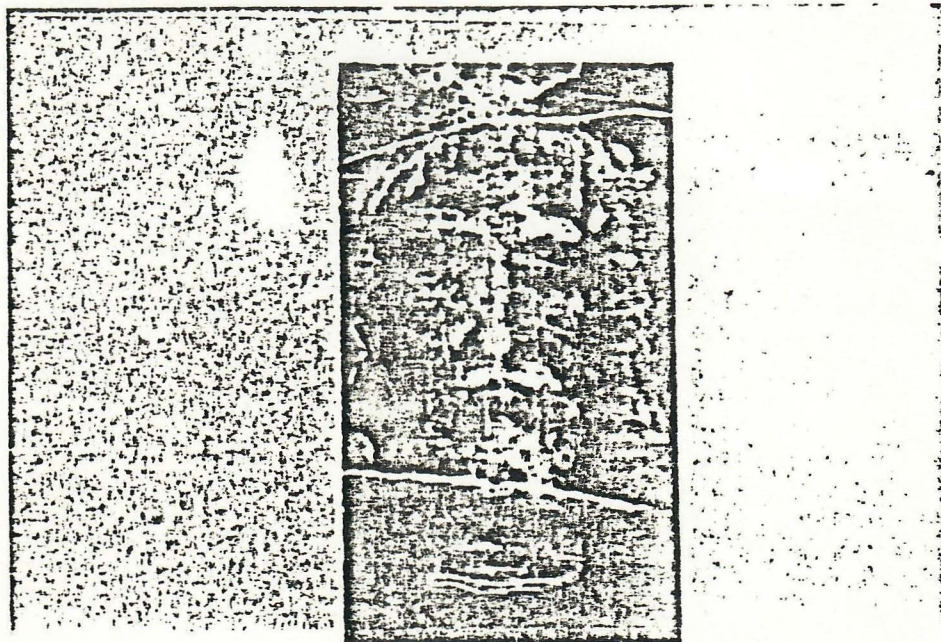

Figure 5. Computer enhanced version of face.

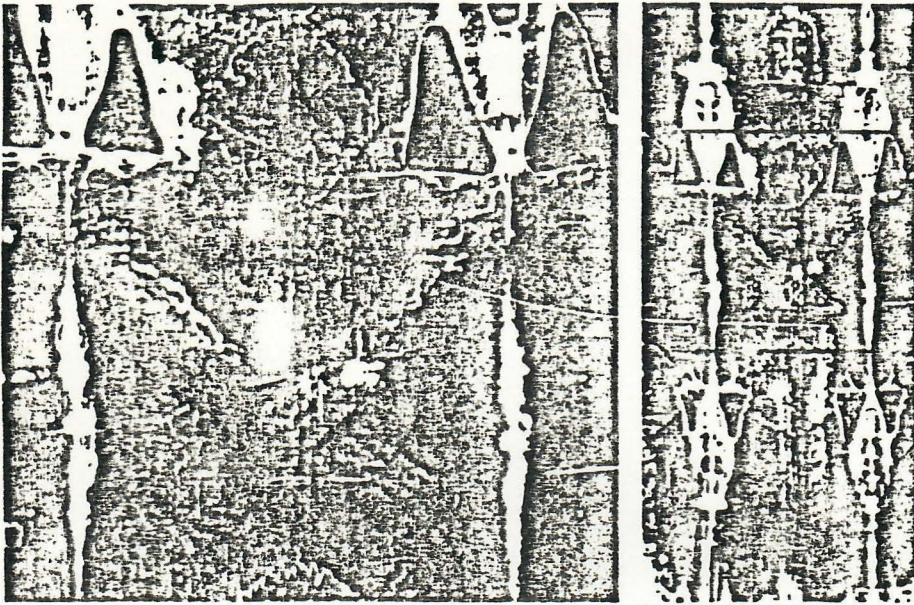

Figure 6. Normal picture of hands.

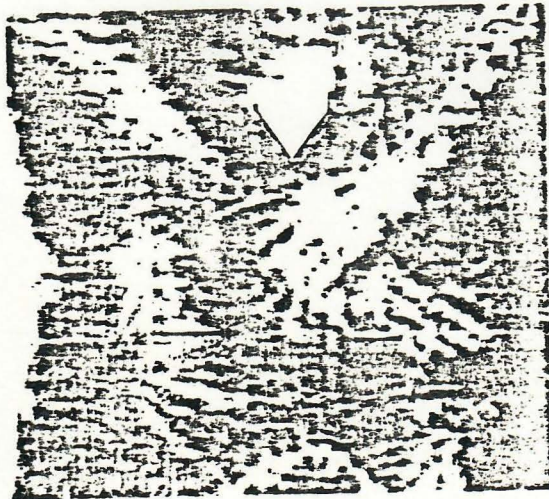

Figure 7. Computer enhanced version of hands. Arrow points to thumblike feature.

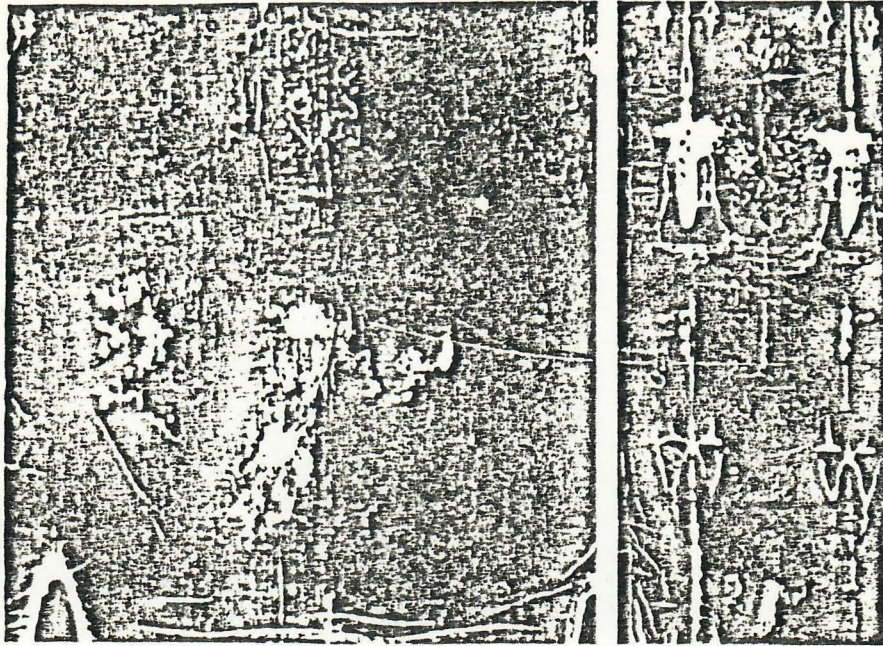

Figure 8. Normal picture of rear side of ankle and foot.

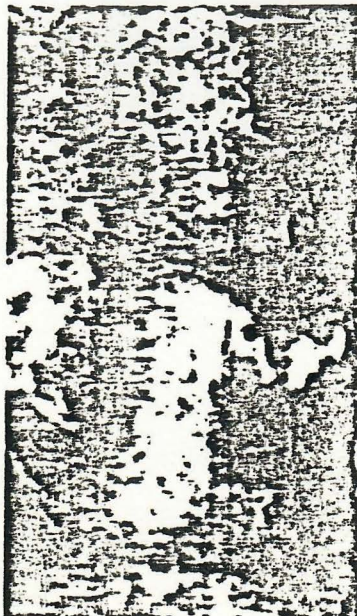

Figure 9. Computer enhanced version of rear side of ankle and foot.

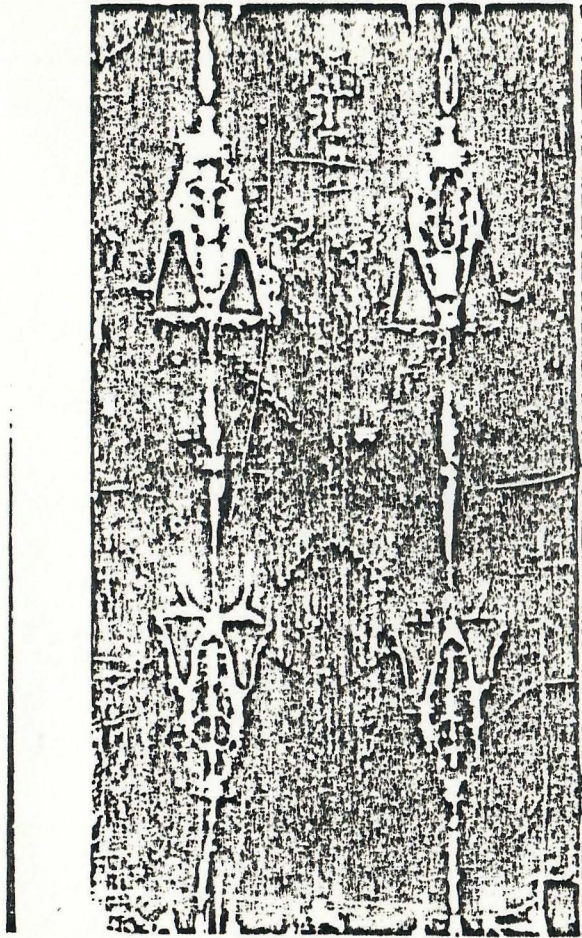

Figure 10. Normal picture of frontal image

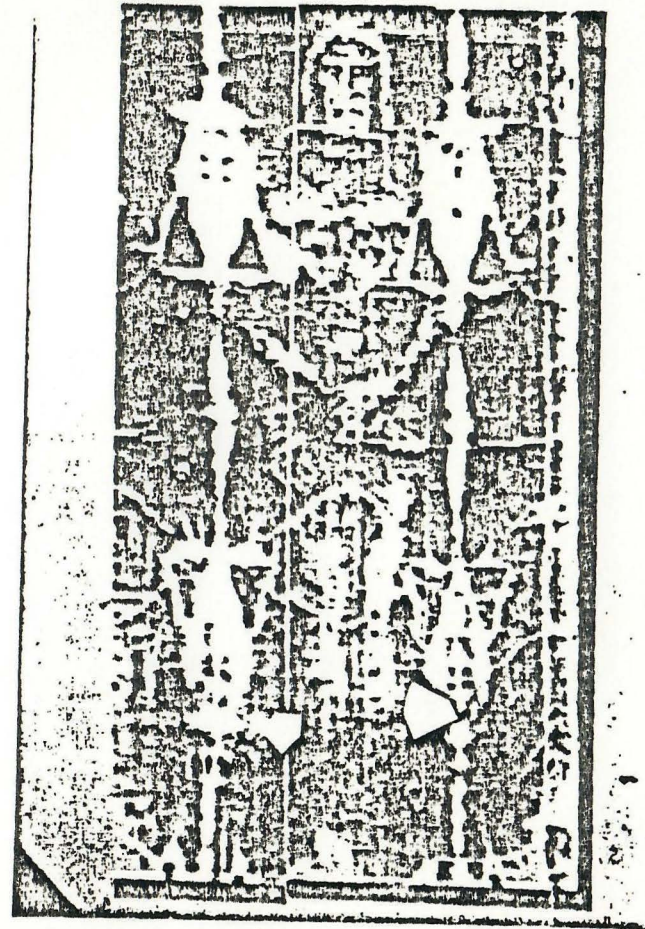

Figure 11. Computer enhanced version of frontal image. Arrows show side image features.

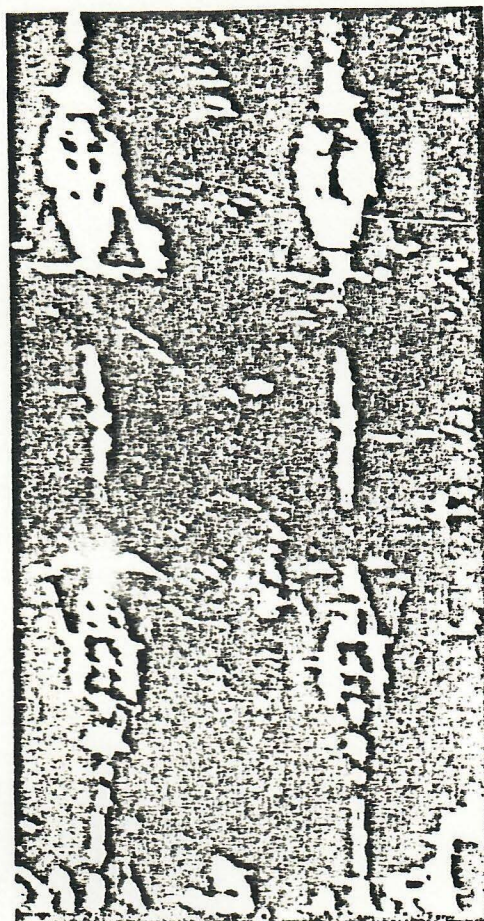

Figure 12. Gamma enhanced version of frontal image. Only lightest portions of body image remain. This picture is a map showing where cloth-body contact occurred.

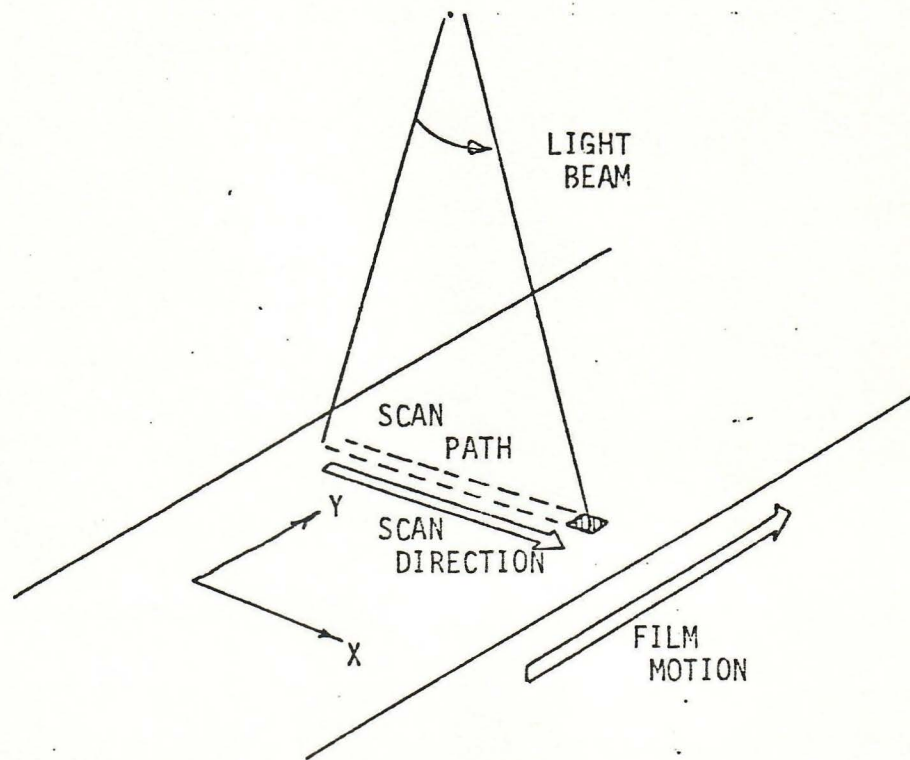

Figure 13. Details of scanning process at film plan. Scanning spot moves in X-direction across film while film is advanced in Y-direction. In this way the entire film transparency is scanned.

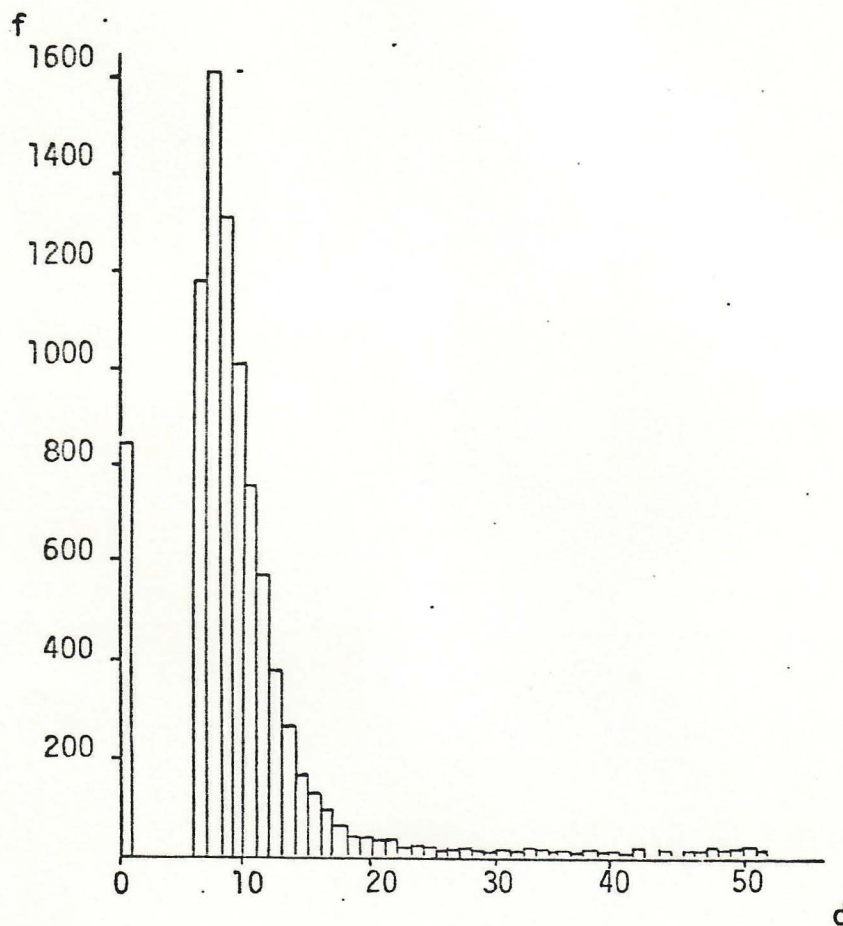

Figure 14. Number of data points on film with a given opacity (density) d . This corresponds to the normal picture of the hand. Note how only a small portion of the available density range is used. Hence, spatial structures of neighboring densities are difficult to distinguish.

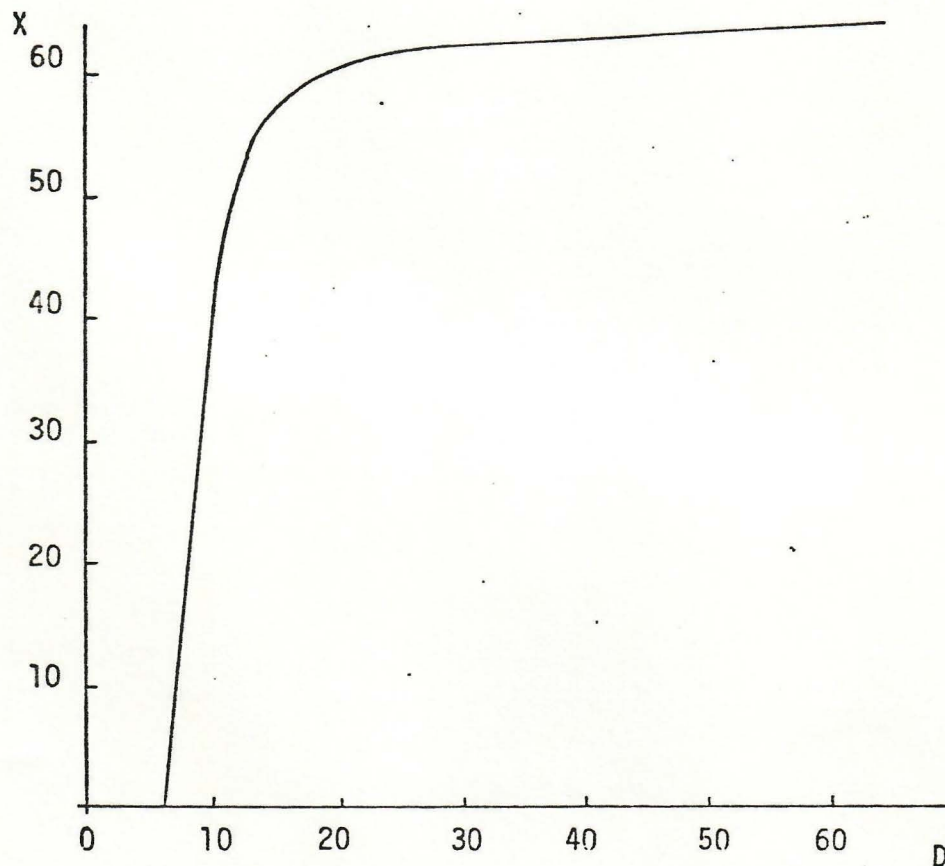

Figure 15. Transformation function $X(D)$ for the hand picture. Each density D of the original in Figure 14 is changed to a new density X .

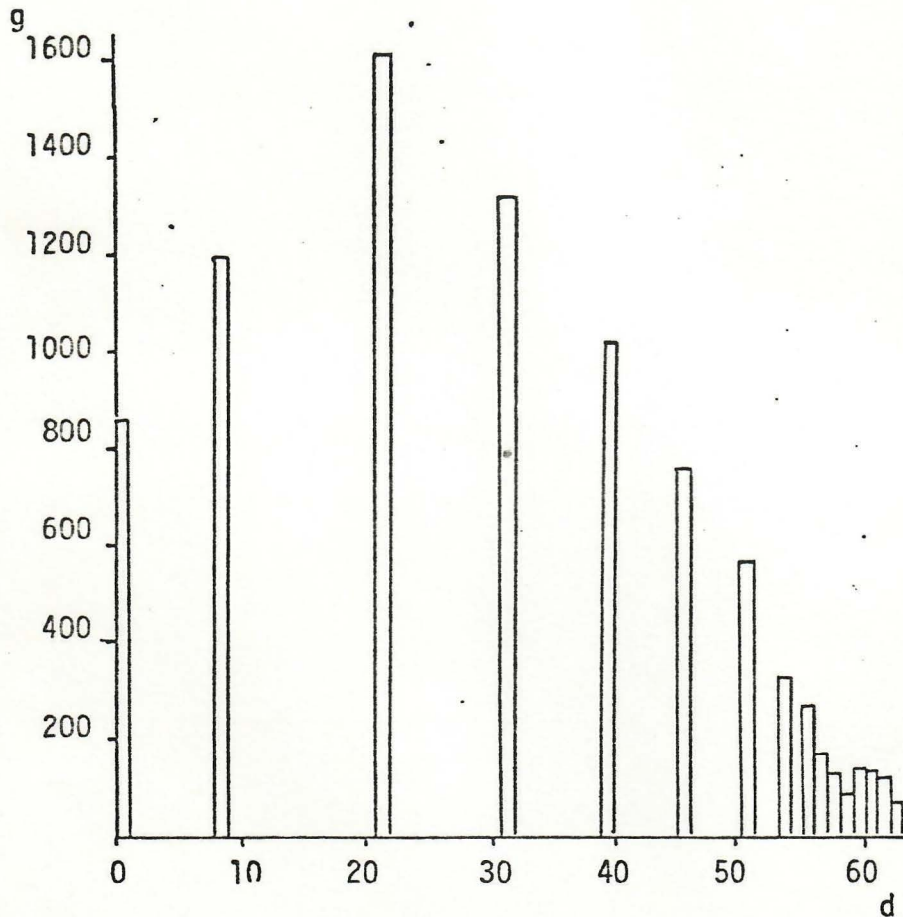

Figure 16. Number of data points on film with a given opacity (density) d . This corresponds to the computer enhanced version of the hand. Note how levels of control are inserted between neighboring densities and how the entire range of densities are utilized. Hence, in contrast to Figure 14, the same spatial structures of neighboring densities are easily distinguished.

CONCLUSIONS AND RECOMMENDATIONS

In summary, then, the results of this first attempt at computer enhancement from somewhat inadequate source transparencies leads us to observe that the computer enhancement technique described above is an effective way in which to obtain new information from the image on the Shroud. Even this first try has led to some new findings. We can only guess, therefore, what other images might become apparent if, instead of scanning second or third generation 1931 Enrie photographs, high resolution, close-up photographs of the Shroud taken with the best of modern photographic equipment could be scanned.

Thus, it is our feeling that this initial effort in the use of computer techniques in the investigation of the Shroud opens the door to further study in this area. Indeed, the potential for improved knowledge of the details of the Shroud imagery is quite real and exciting to us. We do feel that future investigations should be based on much larger transparencies (for improved resolution) which have been created under carefully, preplanned experimental conditions. Such transparencies would permit, for example, actual intensities of light reflected from the Shroud to be deduced from the numerical representation of the image (once an appropriate calibration is made based on measured data of spectral reflectivity on the Shroud) instead of simply the relative level of film opacity (density) which is all that is possible to currently measure from existing imagery. This would allow, for the first time, preparation of a precise, numerical characterization of the

Shroud image in its entirety which any student of the Shroud could use. This ordered collection of data would eliminate many needs of studying the Shroud first hand and would therefore save unnecessary wear and tear on the precious relic by future researchers.

AVENUES FOR FURTHER ENHANCEMENT

The possibilities for further enhancement, especially of improved images, are many ... both with respect to improvement of aesthetic quality, and with respect to extraction of detailed information. On the first level, for example, it would be possible to transform the numerical representation of the Shroud image using the opacity pattern (i.e., gray shades within the face or body features) from the photograph of an actual, undraped human figure of similar physiognomy, taken under the same lighting conditions as the Shroud photographs. This would create the interesting possibility, perhaps, of compensating for any distortions (in contour, and in tonal quality for example) introduced by the cloth, thus approximating the play of light as it might have reflected from the person beneath the Shroud. Yet another technique is available for "filtering out" the weave pattern of the Shroud from the image and thus eliminating any interference that this pattern may be causing with the full visual appreciation of the face imaged on the Shroud.

On the scientific level, it would be possible to obtain from the images detailed, quantitative information as to actual intensity of light reflected from various points on the Shroud as mentioned above. Such information could be an invaluable aid to the continued investigation

of the nature of the process which actually formed the image. Similarly, such quantitative information could permit improved understanding of the drape of the Shroud over the body. Still other techniques are available for specific enhancements of various properties of an image; these include edge enhancement, contour location, detection of specified levels of light reflection, as well as many others. In other words, with a set of Shroud images created under carefully thought out experimental conditions, a very wide range of interesting and significant questions can be asked of those images.

REFERENCES

1. Vignon, Paul, "The Shroud of Christ", University Books, 1970.
2. Barbet, Peirre, "A Doctor at Calvary", Image Books, 1963.
3. Bulst, Werner, "The Shroud of Turin", Bruce Publishing, Co., 1957.
4. Jackson, John and Jumper, Eric, "Characterization of Image Intensity Variation with Cloth-Body Separation on the Holy Shroud by Computer Analysis", to be published, 1975.
5. Wilcox, Robert, private communications.

ACKNOWLEDGMENTS

We would like to express our sincere appreciation to Rev. Adam Otterbein and Rev. Peter Rinaldi for their comments and encouragement in this effort. We would also like to gratefully acknowledge the assistance of Dr. George Anderson, Dr. Walter Dudziak, Jim Nixon, Chuck Webb, Robert Wilcox, Dr. Donald Bruckner, Rudolph Dichtl, Nazareno Rapagnani, Mike Stamm, and of course our wives Kathleen Jackson and Marge Jumper for their encouragement.

A SCIENTIFIC SEARCH: Devan, Jumper, Jackson

Aesthetic enhancement: spiritual and meditative effects

Scientific enhancement: detailed information about specific features

These two are of opposing nature and therefore should properly be treated by separate investigations.

Describes scanning technique and Gamma enhancement

Enhancement reinforces theory of chinband

They think they found a thumb (which does not of course contradict Barbet) (

New images found along legs below knees. No other area of body could show this fanning out: face and top of head covered by chinband, arms bordered by fire burns, hips probably did not touch cloth or come near it because knees and elbows would hold cloth away.

Body images not formed at distances greater than about 5 cm.

These experiments were in fact made on the Don Bosco filmstrip frames.